

RESOLUTION A.378(X)

*Adopted on 14 November 1977
Agenda item 8(b)*

GENERAL PROVISIONS ON SHIPS' ROUTEING

THE ASSEMBLY,

NOTING Article 16(i) of the Convention on the Inter-Governmental Maritime Consultative Organization concerning the functions of the Assembly,

RECOGNIZING that the practice of complying with routeing measures adopted by IMCO for international use has contributed to the safety of navigation by reducing the risk of collisions and strandings,

RECOGNIZING FURTHER that such practice would consequently reduce the risk of pollution of the marine environment and the risk of damage to marine life resulting from collisions or strandings,

NOTING ALSO Rules 1(d) and 10 of the International Regulations for Preventing Collisions at Sea, 1972 which provide for the adoption by the Organization of, and the behaviour of vessels in or near, traffic separation schemes,

RECALLING Regulation 8, Chapter V of the International Convention for the Safety of Life at Sea, 1960 and the amendment thereto adopted by Resolution A.205(VII), whereby IMCO is recognized as the only international body for establishing and adopting routeing measures on an international level,

NOTING that the Ninth International Hydrographic Conference charged the International Hydrographic Bureau to deal with matters relating to the presentation on charts and in sailing directions of details of routeing provisions which have been considered, approved and adopted by IMCO for international use,

HAVING ADOPTED Resolutions A.376(X) and A.377(X) establishing procedures for the adoption of traffic separation schemes and other routeing systems,

DESIRING that all routeing systems including traffic separation schemes thereby adopted conform uniformly to the same general criteria and principles,

HAVING CONSIDERED the Recommendations of the Maritime Safety Committee at its thirty-sixth session,

RECOGNIZING the need to improve the General Provisions on Ships' Routeing as set out in Annex I to Resolution A.284(VIII), taking account of the International Regulations for Preventing Collisions at Sea, 1972,

RESOLVES to adopt the General Provisions on Ships' Routeing approved by the Maritime Safety Committee at its thirty-sixth session, the text of which is annexed to this Resolution,

URGES governments when planning either to introduce new routeing systems or to amend existing systems, to ensure that such systems comply with the general provisions of this Resolution,

REQUESTS:

- (a) the Maritime Safety Committee to revise and update as necessary the publication on "Ships' Routeing" to reflect the decisions taken in this Resolution;
- (b) the Secretary-General to bring this Resolution to the attention of the International Hydrographic Bureau,

REVOKES Annex I to Resolution A.284(VIII).

ANNEX

GENERAL PROVISIONS ON SHIPS' ROUTEING

1. OBJECTIVES

- 1.1 The purpose of ships' routeing is to improve the safety of navigation in converging areas and in areas where the density of traffic is great or where the freedom of movement of shipping is inhibited by restricted sea-room, the existence of obstructions to navigation, limited depths or unfavourable meteorological conditions.
- 1.2 The precise objectives of any routeing system will depend upon the particular hazardous circumstances which it is intended to alleviate, but may include some or all of the following:
 - (a) the separation of opposing streams of traffic so as to reduce the incidence of head-on encounters;
 - (b) the reduction of dangers of collision between crossing traffic and shipping in established traffic lanes;
 - (c) the simplification of the patterns of traffic flow in converging areas;
 - (d) the organization of safe traffic flow in areas of concentrated offshore exploration or exploitation;
 - (e) the organization of traffic flow so as to avoid areas where navigation by all ships or by certain classes of ship is dangerous or undesirable;
 - (f) the reduction of risks of grounding by providing special guidance to deep draught vessels in areas where water depths are uncertain or critical;
 - (g) the guidance of traffic clear of fishing grounds or the organization of traffic through fishing grounds.

2. DEFINITIONS

- 2.1 The following terms are used in connexion with matters related to ships' routeing.
 - (a) ***Routeing system***
Any system of one or more routes and/or routeing measures aimed at reducing the risk of casualties; it includes traffic separation schemes, two-way routes, recommended tracks, areas to be avoided, inshore traffic zones, roundabouts, precautionary areas and deep water routes.
 - (b) ***Traffic separation scheme***
A routeing measure aimed at the separation of opposing streams of traffic by appropriate means and by the establishment of traffic lanes.

- (c) ***Separation zone or line***
A zone or line separating the traffic lanes in which ships are proceeding in opposite or nearly opposite directions, or separating a traffic lane from the adjacent inshore traffic zone.
- (d) ***Traffic lane***
An area within defined limits in which one-way traffic is established. Natural obstacles, including those forming separation zones, may constitute a boundary.
- (e) ***Roundabout***
A routeing measure comprising a separation point or circular separation zone and a circular traffic lane within defined limits. Traffic within the roundabout is separated by moving in a counterclockwise direction around the separation point or zone.
- (f) ***Inshore traffic zone***
A routeing measure comprising a designated area between the landward boundary of a traffic separation scheme and the adjacent coast, intended for local traffic.
- (g) ***Two-way route***
A route within defined limits inside which two-way traffic is established, aimed at providing safe passage of ships through waters where navigation is difficult or dangerous.
- (h) ***Recommended track***
A route which has been specially examined to ensure so far as possible that it is free of dangers and along which ships are advised to navigate.
- (i) ***Deep water route***
A route within defined limits which has been accurately surveyed for clearance of sea bottom and submerged obstacles as indicated on the chart.
- (j) ***Precautionary area***
A routeing measure comprising an area within defined limits where ships must navigate with particular caution and within which the direction of traffic flow may be recommended.
- (k) ***Area to be avoided***
A routeing measure comprising an area within defined limits in which either navigation is particularly hazardous or it is exceptionally important to avoid casualties and which should be avoided by all ships, or certain classes of ship.
- (l) ***Established direction of traffic flow***
A traffic flow pattern indicating the directional movement of traffic as established within a traffic separation scheme.
- (m) ***Recommended direction of traffic flow***
A traffic flow pattern indicating a recommended directional movement of traffic in a routeing system within which it is impractical or unnecessary to adopt an established direction of traffic flow.

3. PROCEDURES AND RESPONSIBILITIES

Procedures and functions of IMCO

- 3.1 IMCO is recognized as the only international body responsible for establishing and recommending measures on an international level concerning ships' routeing.

- 3.2 In deciding whether or not to adopt or amend a traffic separation scheme, IMCO will consider whether:
- (a) the aids to navigation proposed will enable mariners to determine their position with sufficient accuracy to navigate in the scheme in accordance with Rule 10 of the International Regulations for Preventing Collisions at Sea, 1972;
 - (b) the scheme takes account of the accepted planning considerations and complies with the design criteria for traffic separation schemes and with the established methods of routing.
- 3.3 In deciding whether or not to adopt or amend a routing system other than a traffic separation scheme, IMCO will consider whether the aids of navigation are adequate for the purpose of the system and the system takes into account the relevant adopted criteria and methods.
- 3.4 IMCO shall not adopt or amend any routing system without the agreement of the interested coastal States, where that system may affect:
- (a) their rights and practices in respect of the exploitation of living and mineral resources;
 - (b) the environment, traffic pattern or established routing systems in the waters concerned;
 - (c) demands for improvements or adjustments in the navigational aids or hydrographic surveys in the waters concerned.

Responsibilities of governments and recommended practices

- 3.5 A new routing system adopted by IMCO shall not come into force as an IMCO adopted system before an effective date promulgated by the government that proposed the system. That date shall not be earlier than a date agreed by the Organization. Either Notices to Mariners to amend charts, or revised charts to depict the system shall be made available in ample time before the system comes into force.
- 3.6 The selection and development of routing systems is primarily the responsibility of the governments concerned.
- 3.7 A government proposing a new routing system or an amendment to an adopted routing system, any part of which lies beyond its territorial sea, should consult with IMCO so that such system may be adopted or amended by IMCO for international use. Such a system, when adopted, shall not be amended or suspended before consultation with and agreement by IMCO, unless local conditions and the urgency of the case require that earlier action be taken. In considering the proposal IMCO shall take account of the objectives, procedures, responsibilities, methods and criteria for routing systems as set out in these general provisions.
- 3.8 In an emergency such as might result from the unexpected blocking or obstruction of a traffic lane by a wreck or other hazard, immediate temporary changes in the use of the affected traffic separation scheme may be made by the responsible and sponsoring government(s), with the object of directing traffic flow clear of the new hazard. In such cases, every possible measure shall be taken by the governments concerned immediately to inform shipping of the hazard and of the temporary changes which have been made.
- 3.9 Governments are recommended to ensure, as far as practicable, that oil rigs, platforms and other similar structures are not established within routing systems adopted by the Organization or near their terminations. When the temporary positioning of an exploration rig or a similar structure in an adopted traffic separation scheme cannot be avoided, the scheme should, if necessary, be amended temporarily in accordance with the guidelines given in Section 7.

- 3.10 If the above exploration activities lead to the finding of important exploitation prospects, the effect of subsequent exploitation on the safety of marine traffic should be considered carefully. If the establishment of permanent installations within a traffic separation scheme is unavoidable, permanent amendments to the scheme, if deemed necessary, should be submitted to IMCO for adoption.
- 3.11 Governments establishing traffic separation schemes, no parts of which lie beyond their territorial seas, are requested to design them in accordance with IMCO criteria for such schemes and submit them to IMCO for adoption.
- 3.12 Where, for whatever reason, a government decides not to submit a traffic separation scheme to IMCO, it should, in promulgating the scheme to mariners, ensure that there are clear indications on charts and in nautical publications as to what rules apply to the scheme.
- 3.13 Governments establishing routing systems, other than traffic separation schemes, no parts of which lie beyond their territorial seas, are recommended to follow the same procedure as that set out in paragraphs 3.11 and 3.12 above.
- 3.14 Nothing in the General Provisions on Ships' Routing shall prejudice the codification and development of the law of the sea by the United Nations Conference on the Law of the Sea convened pursuant to Resolution 2750 C (XXV) of the General Assembly of the United Nations nor the present or future claims and legal views of any State concerning the law of the sea and the nature and extent of coastal and flag State jurisdiction.

4. METHODS

- 4.1 In meeting the objectives set out in Section 1 the following are among the methods which may be used:

- (a) *The separation of opposing streams of traffic by separation zones, or lines where zones are not possible*

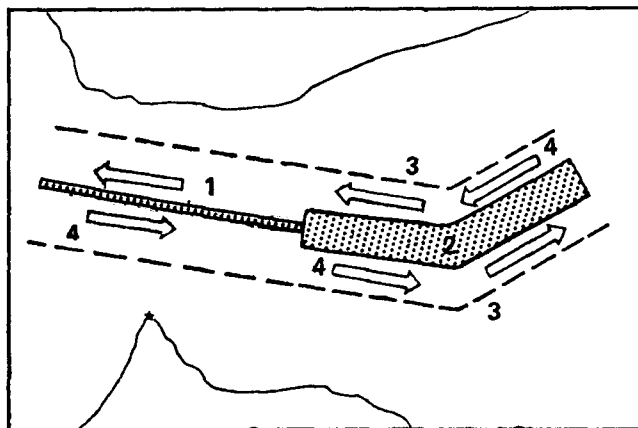

Fig. 1 – Traffic separation by separation zone and line

In this method streams of traffic proceeding in opposite or nearly opposite directions are separated by separation zones (2) or lines (1); the use of zones is to be preferred, but in narrow passages and restricted waters it may be necessary to use a separation line rather than a zone so as to allow more navigable space in the traffic lanes. A length of separation line may also be substituted for a zone in positions where this may encourage and facilitate correct procedures by crossing traffic.

The outside limits (3) of such traffic separation schemes are the outer boundaries of the traffic lanes. The arrows (4) indicate the established direction of traffic flow.

- (b) *The separation of opposing streams of traffic by natural obstructions and geographically defined objects*

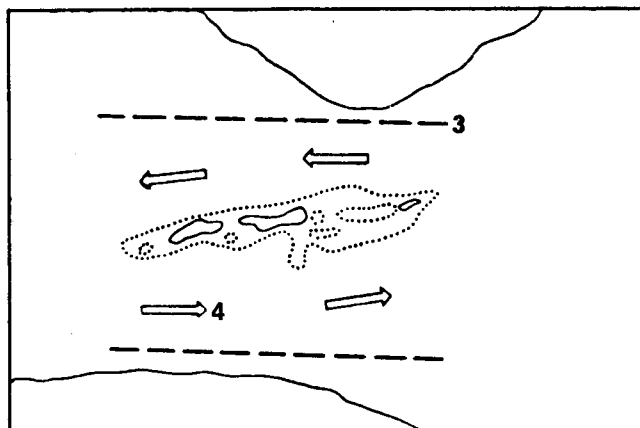

Fig. 2 – Separation of traffic by natural obstructions and geographically defined objects

This method is used where there is a defined area with obstructions such as islands, shoals or rocks restricting free movement and providing a natural division for opposing traffic streams.

- (c) *The separation of through and local traffic by providing inshore traffic zones*

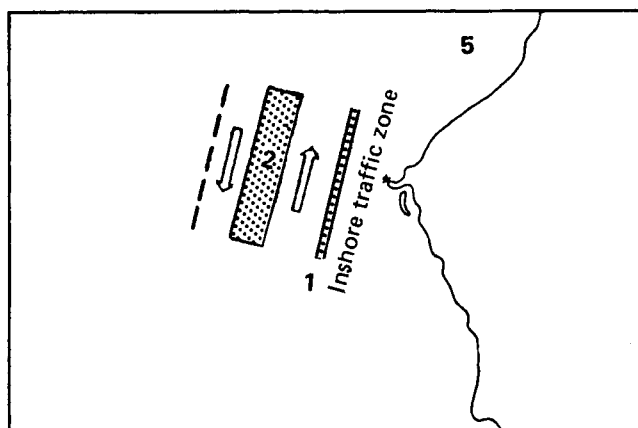

Fig. 3 – Inshore traffic zone for local traffic

Beyond the outside limits of traffic separation schemes, ships may navigate in any direction. Where such areas lie between the traffic separation scheme and the coast they may be designated as inshore traffic zones (5) (see also Figures 4 and 9), with the purpose of keeping local traffic clear of the traffic separation scheme which should be used by through traffic.

Traffic in inshore traffic zones is separated from traffic in the adjacent traffic lane by separation zones (2) or by separation lines (1) (see Figures 4 and 9).

- (d) *The sectorial division of adjacent traffic separation schemes at approaches to focal points*

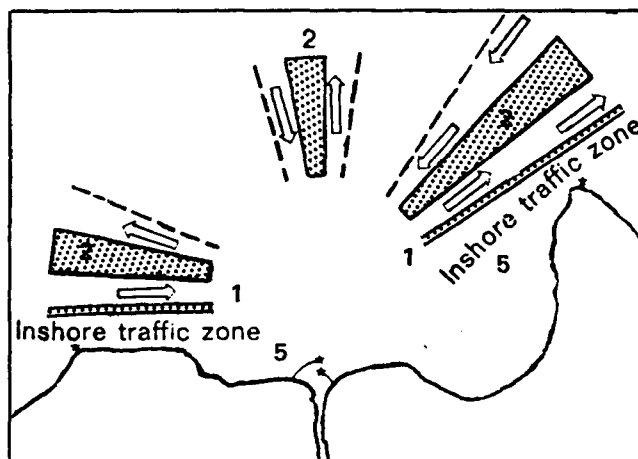

Fig. 4 – Sectorial division of adjacent traffic separation schemes at approaches to focal points

This method is used where ships converge at a focal point or a small area from various directions. Port approaches, sea pilot stations, positions where landfall buoys or light vessels are located, entrances to channels, canals, estuaries, etc. may be considered as such focal points.

- (e) *The routing of traffic at focal points and route junctions where traffic separation schemes meet*

The routing measure to be utilized at focal points, route junctions and intersections should be selected from the most appropriate of the following methods:

- (i) Roundabouts

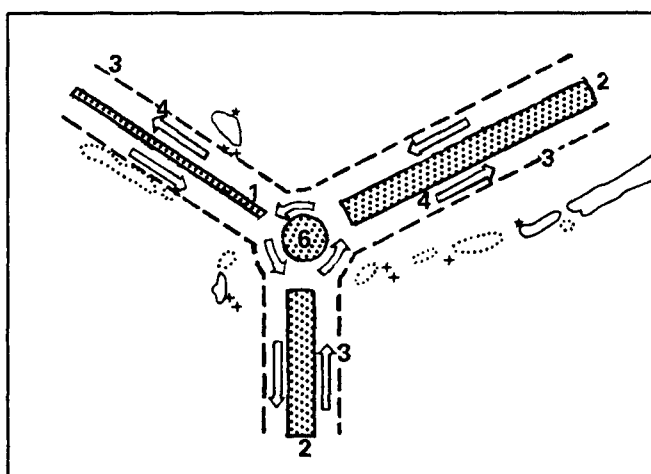

Fig. 5 – Separation of traffic at a roundabout

If the need can be demonstrated a roundabout may be used to guide traffic counterclockwise round a circular separation zone (6) or specified point, as illustrated above.

(ii) Junctions

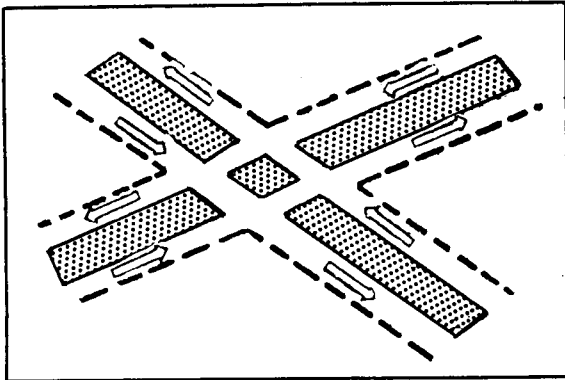

Fig. 6 – Separation of traffic at a crossing

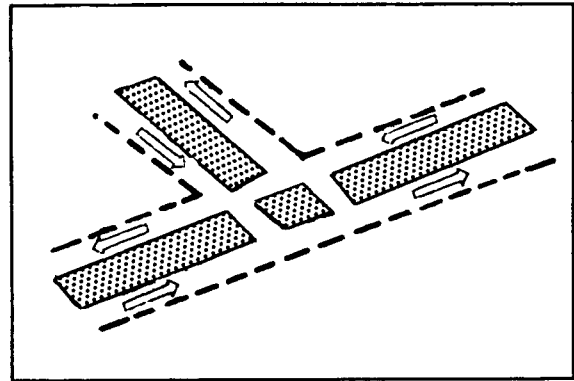

Fig. 7 – Separation of traffic at a junction

This method is used where two routes join or cross. The directions of traffic flow are established in the lanes of the adjoining schemes; the separation zone may be interrupted, as shown in Figures 6 and 7, or replaced by a separation line, in order to emphasize the correct method of crossing by traffic changing from or to the other scheme.

(iii) Precautionary Areas

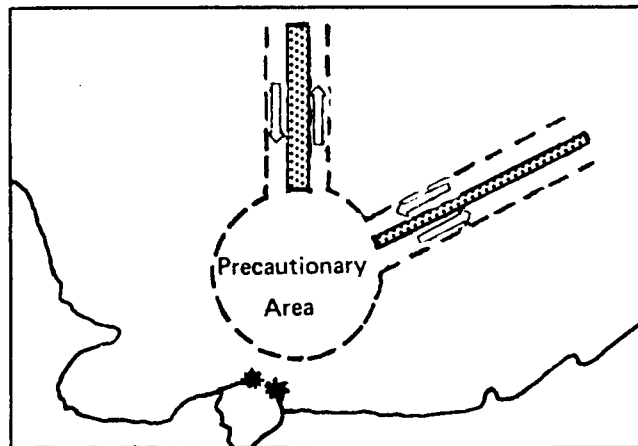

Fig. 8 – Precautionary area at a focal point

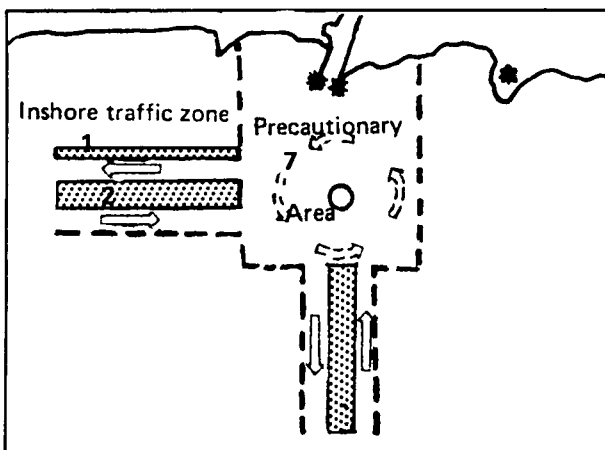

Fig. 9 – Precautionary area with recommended direction of traffic flow around a focal point

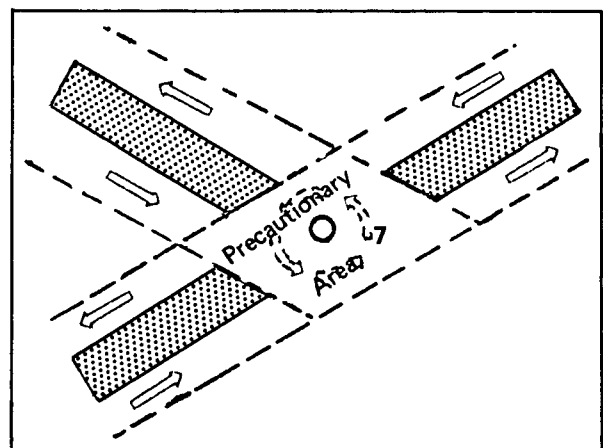

Fig. 10 – Precautionary area at a route junction

It may be best, when routes converge, to terminate them clear of their potential joining points and in such a case a precautionary area can be instituted so as to emphasize the need for care in navigation. Figures 8 and 9 illustrate the use of such an area at focal points; a direction of traffic flow may be recommended (7) around the focal point, as shown in Figure 9.

Figure 10 gives an example of how the same device can be used instead of a route junction. The traffic lanes are terminated short of the point of intersection and replaced by a precautionary area centred on that point, within which a counterclockwise direction of traffic flow may be recommended (7).

Precautionary areas may also be used at the termination of any single route.

(f) *Other routeing methods*

Other routeing methods that may be used are:

- (i) deep water routes;
- (ii) establishment of areas to be avoided;
- (iii) two-way routes and recommended tracks through areas where navigation is difficult or dangerous.

5. PLANNING

- 5.1 Routeing systems should only be established when safety of navigation in the area can thereby be clearly improved.
- 5.2 The routeing system selected for a particular area should aim at providing safe passage for ships through the area without unduly restricting legitimate rights and practices, and taking account of anticipated or existing navigational hazards.
- 5.3 When planning, establishing, reviewing or adjusting a routeing system, the following factors shall be among those taken into account by a government:
- (a) their rights and practices in respect of the exploitation of living and mineral resources;
 - (b) previously established routeing systems in adjacent waters, whether or not under the proposing government's jurisdiction;
 - (c) the existing traffic pattern in the area concerned, including coastal traffic, crossing traffic, naval exercise areas and anchorage areas;
 - (d) foreseeable changes in the traffic pattern resulting from port or offshore terminal developments;
 - (e) the presence of fishing grounds;
 - (f) existing activities and foreseeable developments of offshore exploration or exploitation of the sea-bed;
 - (g) the adequacy of existing aids to navigation, hydrographic surveys and nautical charts of the area;
 - (h) environmental factors including prevailing weather conditions, tidal streams and currents and the possibility of ice concentrations;
 - (i) the existence of environmental conservation areas and the foreseeable developments in the establishment of such areas.
- 5.4 Routeing systems should be reviewed, re-surveyed and adjusted as necessary, so as to maintain their effectiveness and compatibility with trade patterns, offshore exploration and resource exploitation, changes in depths of water, and other developments.

5.5 Routeing systems should not be established in areas where the instability of the sea-bed is such that frequent changes in the alignment and positions of the main channels, and thus of the routeing system itself, are likely.

5.6 When establishing areas to be avoided by all ships or by certain classes of ship, the necessity for creating such areas should be well demonstrated and the reasons stated. In general, these areas should be established only in places where inadequate survey or insufficient provision of aids to navigation may lead to danger of stranding, or where local knowledge is considered essential for safe passage, or where there is the possibility that unacceptable damage to the environment could result from a casualty, or where there might be hazard to a vital navigational aid. These areas shall not be regarded as prohibited areas unless specifically so stated; the classes of ships which should avoid the areas should be considered in each particular case.

6. DESIGN CRITERIA

6.1 The following standards should, so far as the circumstances allow, be applied in the design of ships' routeing measures.

General

6.2 Routes should follow as closely as possible the existing patterns of traffic flow in the areas as determined by traffic surveys.

6.3 The configuration and length of routeing systems which are established to provide for an unobstructed passage through offshore exploration and exploitation areas may differ from the dimensions of normally established systems if the purpose of safeguarding a clear passage warrants such a special feature.

6.4 Course alterations along a route should be as few as possible and should be avoided in the approaches to convergence areas and route junctions or where crossing traffic may be expected to be heavy.

6.5 The number of convergence areas and route junctions should be kept to a minimum, and should be as widely separated from each other as possible. Adjacent traffic separation schemes should be placed such that nearly opposing streams of traffic in the adjacent schemes are separated as widely as possible. Route junctions should not be located where concentrated crossing traffic, not following established routes, may be expected, e.g. ferry traffic.

6.6 Routes should be designed to allow optimum use of aids to navigation in the area, and of such shipborne navigational aids as are required or recommended to be fitted by international conventions or by IMCO resolutions and recommendations.

Traffic separation schemes

6.7 The extent of a traffic separation scheme should be limited to what is essential in the interests of safe navigation.

6.8 Traffic lanes should be designed to make optimum use of available depths of water and the safe navigable areas taking into account the maximum depth of water attainable along the length of the route. The width of lanes should take account of the traffic density, the general usage of the area and of the sea-room available.

6.9 Where there is sufficient space, separation zones should be used in preference to separation lines to separate opposing streams of traffic and to segregate inshore traffic zones from adjacent traffic lanes.

- 6.10 It should be possible for ships to fix their position anywhere within the limits and in the immediate approaches to a traffic separation scheme by one or more of the following means, both by day and night:
- (a) visual bearings of readily identifiable objects;
 - (b) radar bearings and ranges of readily identifiable objects;
 - (c) D/F bearings.
- 6.11 The minimum widths of traffic lanes and of traffic separation zones should be related to the accuracy of the available position-fixing methods, accepting the appropriate performance standards for shipborne equipment as set out in IMCO resolutions and recommendations.
- 6.12 Where space allows the use of traffic separation zones the width of the zone should, if possible, be not less than three times the transverse component of the standard error (measured across the separation zone) of the most appropriate of the fixing methods listed in paragraph 6.10. Where necessary and practicable, additional separation should be provided so as to ensure that there will be adequate early indication that traffic proceeding in the opposite direction will pass on the correct side.
- 6.13 If there is doubt as to ships being able to fix their positions positively and without ambiguity in relation to separation lines or zones, serious consideration should be given to providing adequate marking by buoys.

Converging and junction areas

- 6.14 Whichever of the several available routeing methods is chosen for use at a route junction or in a converging area, it must be a cardinal principle that any ambiguity or possible source of confusion in the application of the Collision Regulations must be avoided. This principle should be particularly borne in mind when establishing or recommending the direction of traffic flow in such areas.
- 6.15 At route junctions the following particular considerations apply:
- (a) the need to encourage the crossing of traffic lanes as nearly as possible at right angles;
 - (b) the need to give ships which may be required to give way under the Collision Regulations as much room to manoeuvre as possible;
 - (c) the need to enable a stand-on vessel to maintain a steady course, as required by the Collision Regulations, for as long as possible before the route junction;
 - (d) the need to encourage traffic not following an established route to avoid crossing at or near route junctions.

Deep water routes

- 6.16 In designing deep water routes, consideration should be given to marking critical turning points. Any wrecks or sea-bed obstructions which lie within the limits of a deep water route and which have less depth of water over them than the minimum depth of water for the route as indicated on the charts, should be marked.

7. TEMPORARY ADJUSTMENTS TO TRAFFIC SEPARATION SCHEMES

7.1 When the temporary positioning of an exploration rig is unavoidable, the design criteria and the provisions for planning should be taken into account before permitting the positioning of the rig or subsequently adjusting a traffic separation scheme,

7.2 The said adjustments should be made in accordance with the following:

- (a) When the drilling location is situated near the boundary of a lane or traffic separation zone, a relatively slight adjustment of the scheme could have such effect that the drilling rig and its associated safety zone is sufficiently clear of the traffic lane;

Example

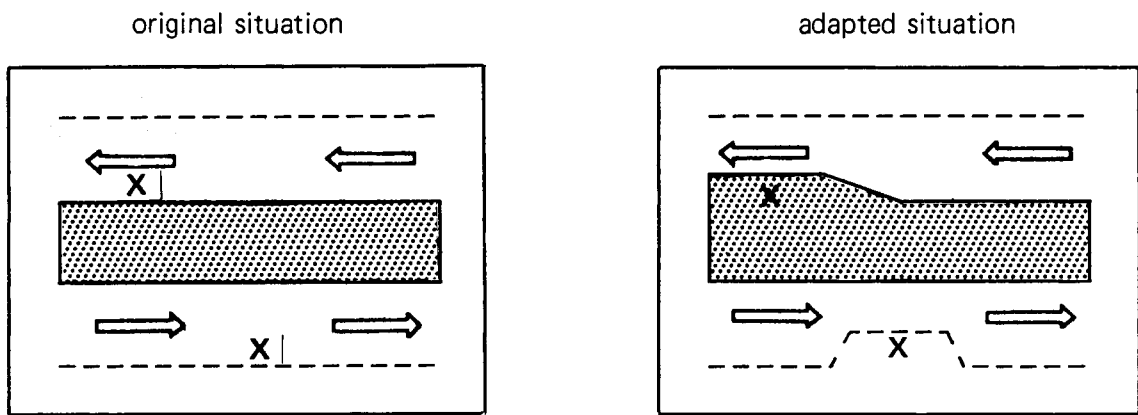

- (b) if a small temporary adjustment of the traffic lane is not possible the whole or part of the scheme could be temporarily shifted in order to clear the drilling area from the lane so that traffic connected with the drilling operations will stay clear of the lane;

Example

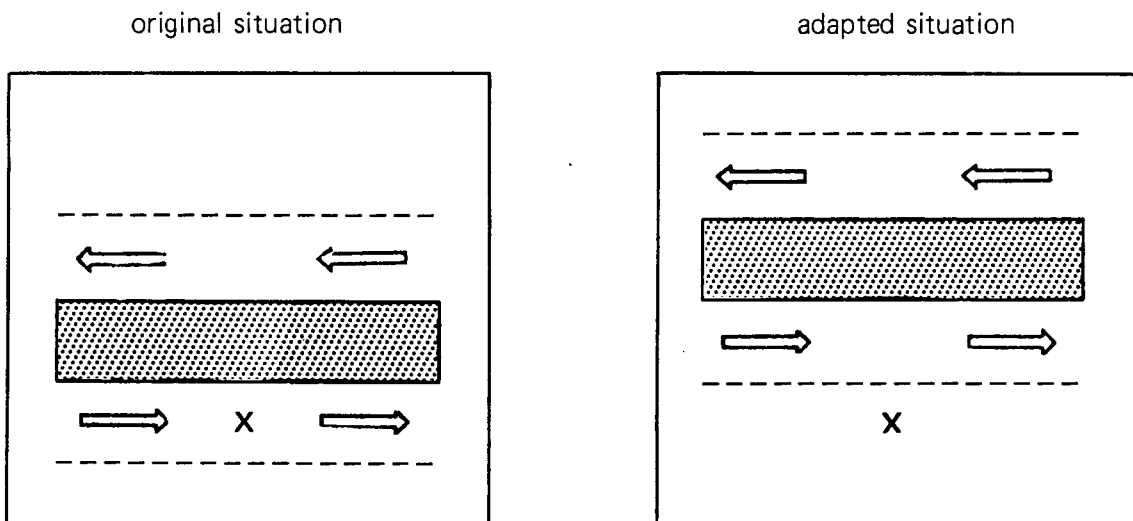

- (c) temporary local interruption of the scheme or part of the scheme in the area of location of the drilling rig. Such an interruption could be made a precautionary area;

Example

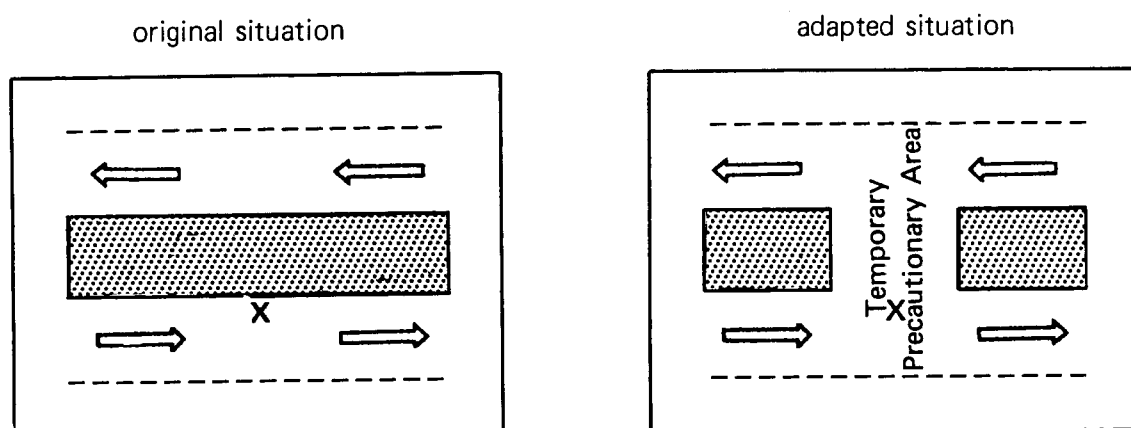





- (d) temporary suspension of the whole scheme.

- 7.3 In each case, exploration sites should be reviewed and such conditions specified as the Administration may deem necessary to ensure safety of navigation in the area.
- 7.4 Details of these temporary adjustments should be forwarded to the Organization and to appropriate hydrographic offices at least two months before the rig is positioned within an adopted traffic separation scheme so as to allow ample time for informing shipping.
- ## 8. THE USE OF ROUTEING SYSTEMS
- 8.1 Routeing systems are intended for use by day and by night in all weathers, in ice-free waters or under light ice conditions where no extraordinary manoeuvres or assistance by ice breaker(s) are required.
- 8.2 Routeing systems are recommended for use by all ships unless stated otherwise. Bearing in mind the need for adequate underkeel clearance, a decision to use a routeing system must take into account the charted depth, the possibility of changes in the sea-bed since the time of the last survey, and the effects of meteorological and tidal conditions on water depths.
- 8.3 A ship navigating in or near a traffic separation scheme adopted by the Organization shall in particular comply with Rule 10 of the International Regulations for Preventing Collisions at Sea, 1972 to minimize the development of risk of collision with another ship. The other rules of the 1972 Collision Regulations apply in all respects, and particularly the steering and sailing rules if risk of collision with another ship is deemed to exist.
- 8.4 At junction points where route traffic from various directions meet, a true separation of traffic is not really possible, as ships may need to cross routes or change to another route. Ships should therefore navigate with great caution in such areas and be aware that the mere fact that a ship is proceeding along a through-going route gives that ship no special privilege or right of way.

- 8.5 A deep water route is primarily intended for use by ships which because of their draught in relation to the available depth of water in the area concerned require the use of such a route. Through traffic to which the above consideration does not apply should, as far as practicable, avoid using deep water routes.
- 8.6 In two-way routes, including two-way deep water routes, ships should as far as practicable keep to the starboard side.
- 8.7 Arrows printed on charts in connexion with routeing systems merely indicate the general direction of established or recommended traffic flow; ships need not set their courses strictly along the arrows.
- 8.8 The signal "YG" meaning "You appear not to be complying with the traffic separation scheme" is provided in the International Code of Signals for appropriate use.

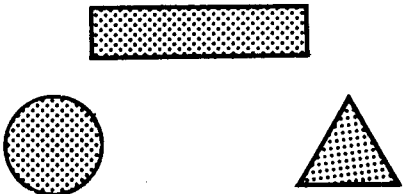
9. SYMBOLS

9.1 The symbols in the following table are those recommended by the International Hydrographic Organization for representation of details of routeing systems and associated measures on nautical charts. They are included for information on what may be generally found on charts. Individual countries may, however, use on their charts symbols differing from those given below.

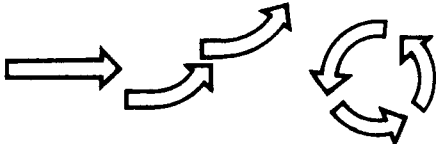
Detail (The figures in brackets refer to the Remarks)	Presentation	Description
1. Outside boundary of traffic lanes and two-way routes		Dashed line — the symbol used for maritime limits in general
2. Separation zone (of any shape) (1) (2)		A zone indicated by a tint light enough to reveal any hydrographic details
3. Separation line (2)		A tinted line at least 3 mm wide
4. Outside boundary of roundabout or precautionary area (3)		Dashed line — the symbol used for maritime limits in general
5. Centre of a roundabout which contains no central zone		A firm-line circle of at least 3 mm in diameter
6. Arrows indicating established direction of traffic flow (4)		Open-outlined arrows so situated and shaped as to indicate general direction of traffic flow

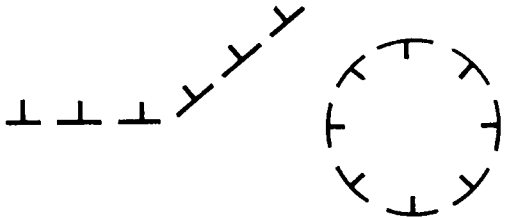
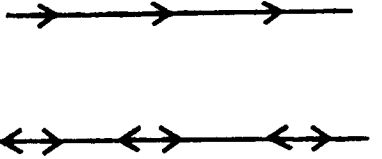
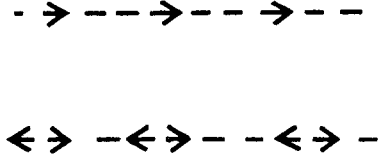
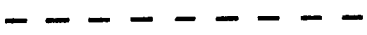
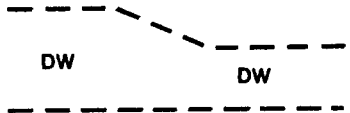
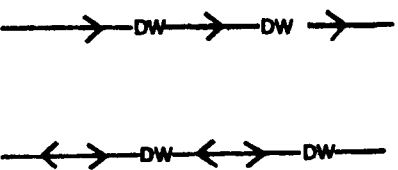
Detail (The figures in brackets refer to the Remarks)	Presentation	Description
7. Arrows indicating the recommended direction of traffic flow (certain stipulated classes of ships may be exempt) (4)		Dashed open-outlined arrows so situated and shaped as to indicate general recommended direction of traffic flow
8. Boundary of areas to be avoided (6) (5)		A line composed of a series of T-shaped signs, the cross bar of the T being long and the down stroke short and pointing towards the area in question, within which a suitable legend may be inscribed
9. Recommended track when based on a system of fixed marks (7)		A single continuous line in black or colour in which arrowheads are inserted at regular intervals either singly to represent a one-way track, or in opposing pairs to represent a two-way track
10. Recommended track when not based on a system of fixed marks (7)		A single dashed line, in black or colour, in which arrowheads are inserted at regular intervals either singly to represent a one-way track, or in opposing pairs to represent a two-way track
11. Outside boundary of deep water route		Dashed line — the symbol used for maritime limits in general
12. Deep water route with both outside boundaries depicted (8)		Dashed lines and the abbreviation DW inserted at regular intervals between them
13. Deep water route, based on fixed marks (8) (9)		A single continuous line in which arrowheads are inserted at regular intervals, either singly to represent a one-way route, or in opposing pairs, to represent a two-way route. The abbreviation DW is inserted at regular intervals along the continuous line

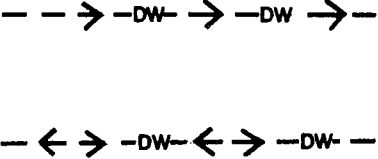
Detail (The figures in brackets refer to the Remarks)	Presentation	Description
14. Deep water route not based on fixed marks (8) (9)		A single dashed line in which arrowheads are inserted at regular intervals; either singly to represent a one-way route, or in opposing pairs, to represent a two-way route. The abbreviation DW is inserted at regular intervals along the dashed line

Remarks

- (1) If the traffic lanes are separated by natural features (islands, marked shoals etc.) representation of the separation zone may be omitted.
- (2) Used also to mark the boundary between a traffic lane and an adjoining inshore traffic zone.
- (3) The dashed line representing the outside boundary of a roundabout should be broken at the junctions between the traffic lanes and the roundabout. This may also be done for precautionary areas if considered appropriate.
- (4) It is preferable that the arrows be inserted in dispersed or staggered formation, instead of placing them in straight lines.
- (5) Notes on conditions of avoidance (classes and sizes of ships, nature of cargoes carried, etc.) may be given on charts and should always be given in Sailing Directions.
- (6) This symbol is also used to indicate the boundary of offshore exploration and exploitation areas where navigation may be dangerous.
- (7) A usual feature of recommended tracks is that they occur fairly close inshore and are intended primarily to help ships avoid shoal depths, rather than to regulate shipping movements. In such cases, they are usually charted in black.
- (8) When the minimum depth along a **DW** route is considered critical, the depth may be indicated beside the abbreviation **DW**. However, unless the critical depths within the limits of the **DW** route are regularly examined and confirmed by a competent harbour, regional or national authority, it is unlikely that such a minimum depth can be quoted on the chart. The least depths obtained during the survey investigation of the **DW** route will be apparent by the display of selected soundings shown on the chart in the usual manner. In some cases, a NOTE on the chart gives further information regarding date of survey, etc.
- (9) The symbols 13 and 14 in the table above are identical to those for Recommended Tracks (see symbols 9 and 10) with the addition of abbreviation **DW**. Particularly on a two-way route, deep draught vessels will rarely be able to adhere strictly to a single centre line and, for this reason, it is preferable that a **DW** route be shown on charts by symbol 12 which clearly indicates the extent of the area which has been accurately surveyed for clearance of sea bottom and submerged objects.

General observations

- 9.2 The International Hydrographic Organization has recommended that routeing and traffic separation symbols used on charts should be printed in colour, preferably magenta.
- 9.3 Secondary details of routeing and traffic separation, such as figures indicating directions of traffic, schemes and their details, dimensions, distances from coast etc., should not be shown on charts unless considered critical. These may, however, be given in Sailing Directions, if so decided by hydrographic offices.

- 3.10 If the above exploration activities lead to the finding of important exploitation prospects, the effect of subsequent exploitation on the safety of marine traffic should be considered carefully. If the establishment of permanent installations within a traffic separation scheme is unavoidable, permanent amendments to the scheme, if deemed necessary, should be submitted to IMCO for adoption.
- 3.11 Governments establishing traffic separation schemes, no parts of which lie beyond their territorial seas, are requested to design them in accordance with IMCO criteria for such schemes and submit them to IMCO for adoption.
- 3.12 Where, for whatever reason, a government decides not to submit a traffic separation scheme to IMCO, it should, in promulgating the scheme to mariners, ensure that there are clear indications on charts and in nautical publications as to what rules apply to the scheme.
- 3.13 Governments establishing routing systems, other than traffic separation schemes, no parts of which lie beyond their territorial seas, are recommended to follow the same procedure as that set out in paragraphs 3.11 and 3.12 above.
- 3.14 Nothing in the General Provisions on Ships' Routing shall prejudice the codification and development of the law of the sea by the United Nations Conference on the Law of the Sea convened pursuant to Resolution 2750 C (XXV) of the General Assembly of the United Nations nor the present or future claims and legal views of any State concerning the law of the sea and the nature and extent of coastal and flag State jurisdiction.

4. METHODS

- 4.1 In meeting the objectives set out in Section 1 the following are among the methods which may be used:

- (a) *The separation of opposing streams of traffic by separation zones, or lines where zones are not possible*

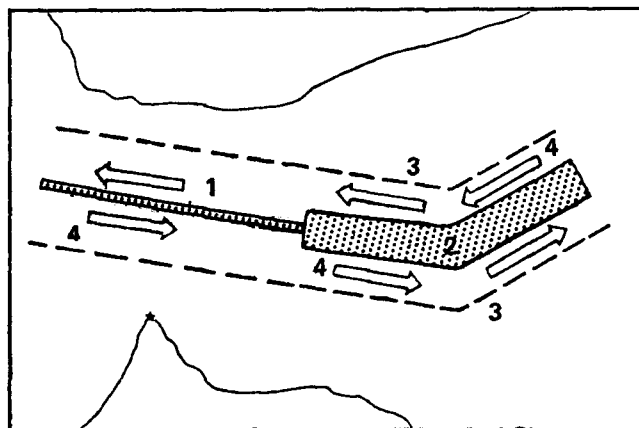

Fig. 1 – Traffic separation by separation zone and line

In this method streams of traffic proceeding in opposite or nearly opposite directions are separated by separation zones (2) or lines (1); the use of zones is to be preferred, but in narrow passages and restricted waters it may be necessary to use a separation line rather than a zone so as to allow more navigable space in the traffic lanes. A length of separation line may also be substituted for a zone in positions where this may encourage and facilitate correct procedures by crossing traffic.

The outside limits (3) of such traffic separation schemes are the outer boundaries of the traffic lanes. The arrows (4) indicate the established direction of traffic flow.

- (b) *The separation of opposing streams of traffic by natural obstructions and geographically defined objects*

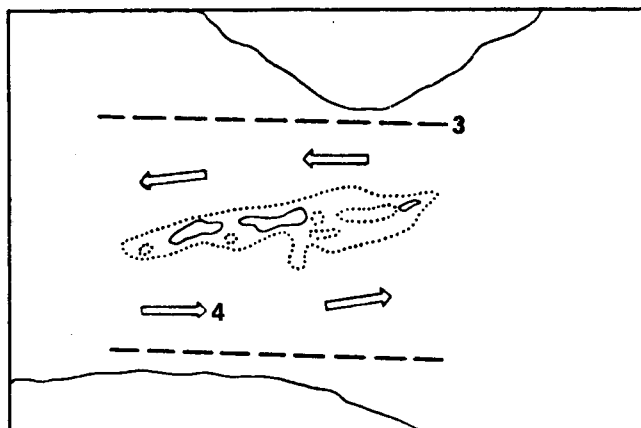

Fig. 2 – Separation of traffic by natural obstructions and geographically defined objects

This method is used where there is a defined area with obstructions such as islands, shoals or rocks restricting free movement and providing a natural division for opposing traffic streams.

- (c) *The separation of through and local traffic by providing inshore traffic zones*

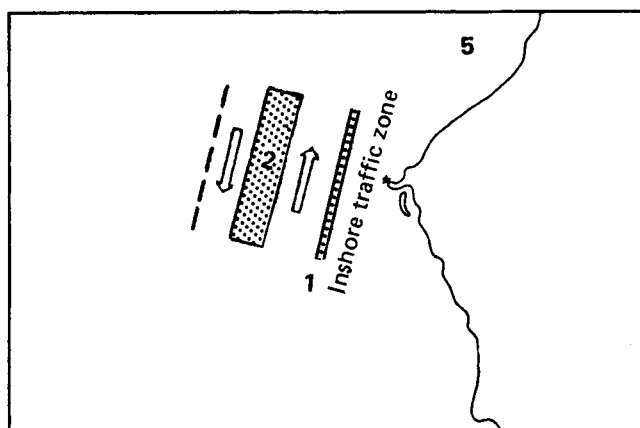

Fig. 3 – Inshore traffic zone for local traffic

Beyond the outside limits of traffic separation schemes, ships may navigate in any direction. Where such areas lie between the traffic separation scheme and the coast they may be designated as inshore traffic zones (5) (see also Figures 4 and 9), with the purpose of keeping local traffic clear of the traffic separation scheme which should be used by through traffic.

Traffic in inshore traffic zones is separated from traffic in the adjacent traffic lane by separation zones (2) or by separation lines (1) (see Figures 4 and 9).

- (d) *The sectorial division of adjacent traffic separation schemes at approaches to focal points*

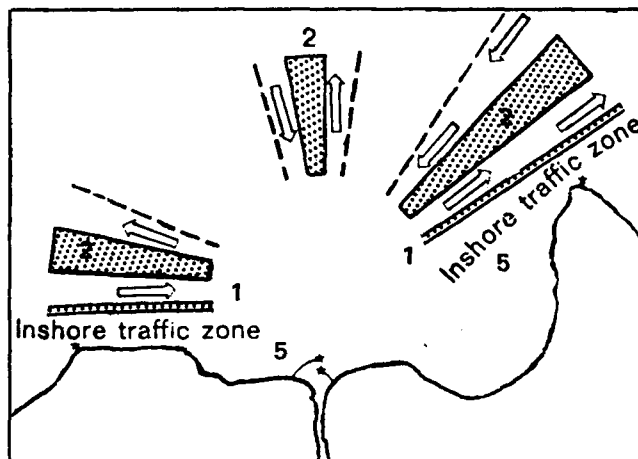

Fig. 4 – Sectorial division of adjacent traffic separation schemes at approaches to focal points

This method is used where ships converge at a focal point or a small area from various directions. Port approaches, sea pilot stations, positions where landfall buoys or light vessels are located, entrances to channels, canals, estuaries, etc. may be considered as such focal points.

- (e) *The routing of traffic at focal points and route junctions where traffic separation schemes meet*

The routing measure to be utilized at focal points, route junctions and intersections should be selected from the most appropriate of the following methods:

- (i) Roundabouts

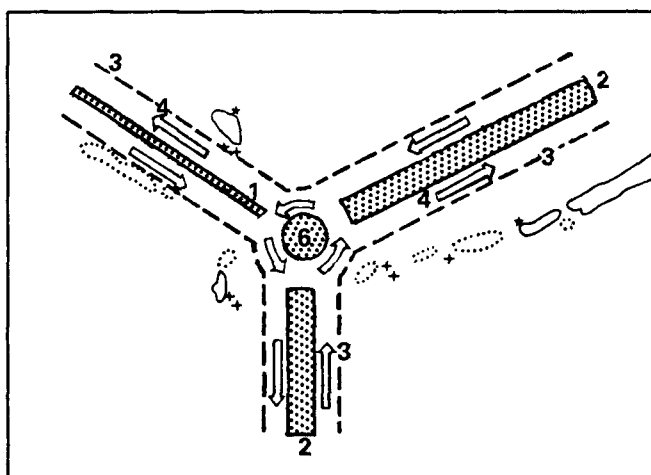

Fig. 5 – Separation of traffic at a roundabout

If the need can be demonstrated a roundabout may be used to guide traffic counterclockwise round a circular separation zone (6) or specified point, as illustrated above.

(ii) Junctions

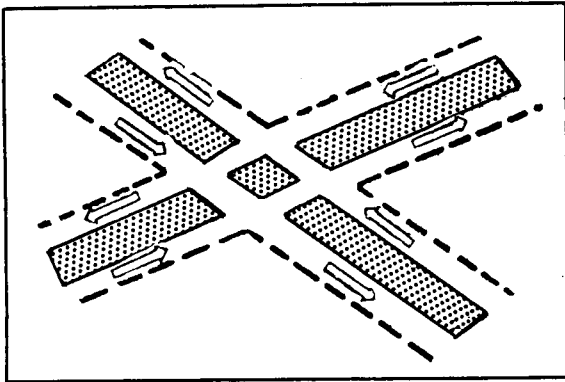

Fig. 6 – Separation of traffic at a crossing

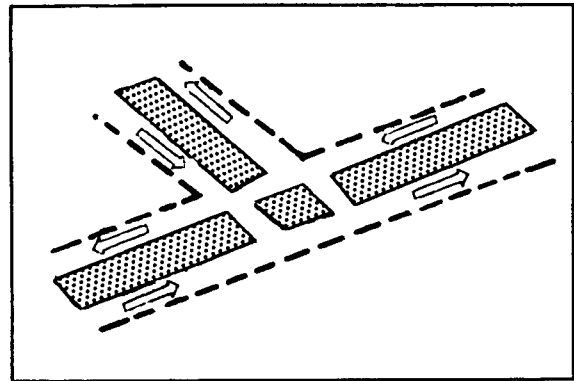

Fig. 7 – Separation of traffic at a junction

This method is used where two routes join or cross. The directions of traffic flow are established in the lanes of the adjoining schemes; the separation zone may be interrupted, as shown in Figures 6 and 7, or replaced by a separation line, in order to emphasize the correct method of crossing by traffic changing from or to the other scheme.

(iii) Precautionary Areas

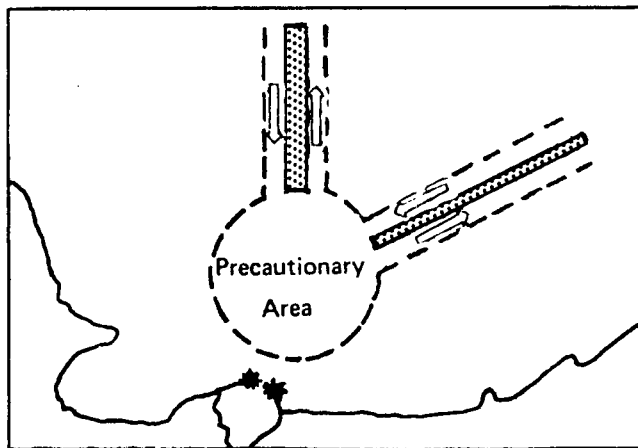

Fig. 8 – Precautionary area at a focal point

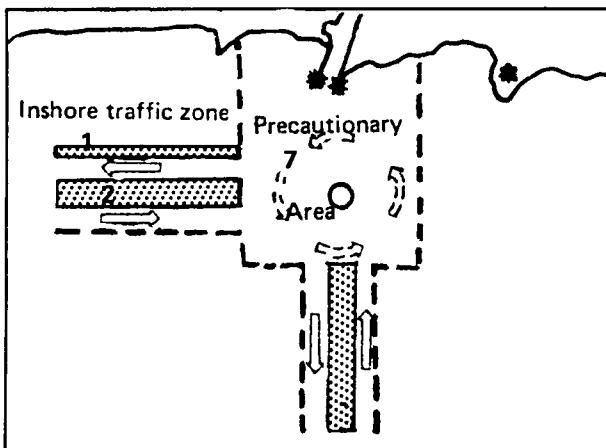

Fig. 9 – Precautionary area with recommended direction of traffic flow around a focal point

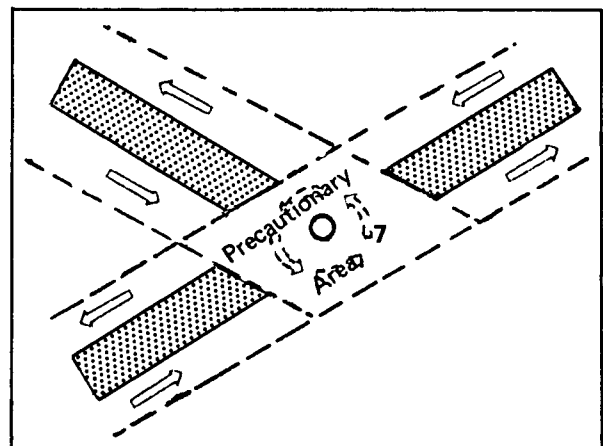

Fig. 10 – Precautionary area at a route junction

It may be best, when routes converge, to terminate them clear of their potential joining points and in such a case a precautionary area can be instituted so as to emphasize the need for care in navigation. Figures 8 and 9 illustrate the use of such an area at focal points; a direction of traffic flow may be recommended (7) around the focal point, as shown in Figure 9.

Figure 10 gives an example of how the same device can be used instead of a route junction. The traffic lanes are terminated short of the point of intersection and replaced by a precautionary area centred on that point, within which a counterclockwise direction of traffic flow may be recommended (7).

Precautionary areas may also be used at the termination of any single route.

(f) *Other routeing methods*

Other routeing methods that may be used are:

- (i) deep water routes;
- (ii) establishment of areas to be avoided;
- (iii) two-way routes and recommended tracks through areas where navigation is difficult or dangerous.

5. PLANNING

- 5.1 Routeing systems should only be established when safety of navigation in the area can thereby be clearly improved.
- 5.2 The routeing system selected for a particular area should aim at providing safe passage for ships through the area without unduly restricting legitimate rights and practices, and taking account of anticipated or existing navigational hazards.
- 5.3 When planning, establishing, reviewing or adjusting a routeing system, the following factors shall be among those taken into account by a government:
- (a) their rights and practices in respect of the exploitation of living and mineral resources;
 - (b) previously established routeing systems in adjacent waters, whether or not under the proposing government's jurisdiction;
 - (c) the existing traffic pattern in the area concerned, including coastal traffic, crossing traffic, naval exercise areas and anchorage areas;
 - (d) foreseeable changes in the traffic pattern resulting from port or offshore terminal developments;
 - (e) the presence of fishing grounds;
 - (f) existing activities and foreseeable developments of offshore exploration or exploitation of the sea-bed;
 - (g) the adequacy of existing aids to navigation, hydrographic surveys and nautical charts of the area;
 - (h) environmental factors including prevailing weather conditions, tidal streams and currents and the possibility of ice concentrations;
 - (i) the existence of environmental conservation areas and the foreseeable developments in the establishment of such areas.
- 5.4 Routeing systems should be reviewed, re-surveyed and adjusted as necessary, so as to maintain their effectiveness and compatibility with trade patterns, offshore exploration and resource exploitation, changes in depths of water, and other developments.

7. TEMPORARY ADJUSTMENTS TO TRAFFIC SEPARATION SCHEMES

7.1 When the temporary positioning of an exploration rig is unavoidable, the design criteria and the provisions for planning should be taken into account before permitting the positioning of the rig or subsequently adjusting a traffic separation scheme.

7.2 The said adjustments should be made in accordance with the following:

- (a) When the drilling location is situated near the boundary of a lane or traffic separation zone, a relatively slight adjustment of the scheme could have such effect that the drilling rig and its associated safety zone is sufficiently clear of the traffic lane;

Example

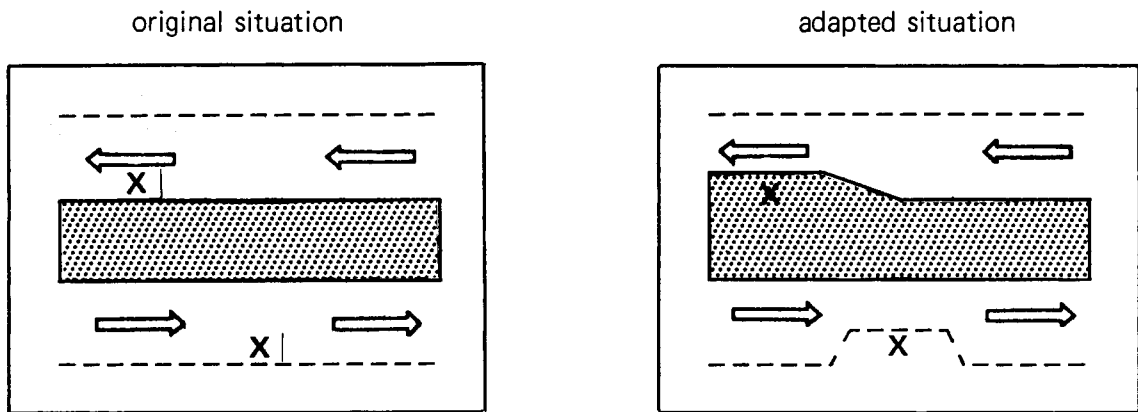

- (b) if a small temporary adjustment of the traffic lane is not possible the whole or part of the scheme could be temporarily shifted in order to clear the drilling area from the lane so that traffic connected with the drilling operations will stay clear of the lane;

Example

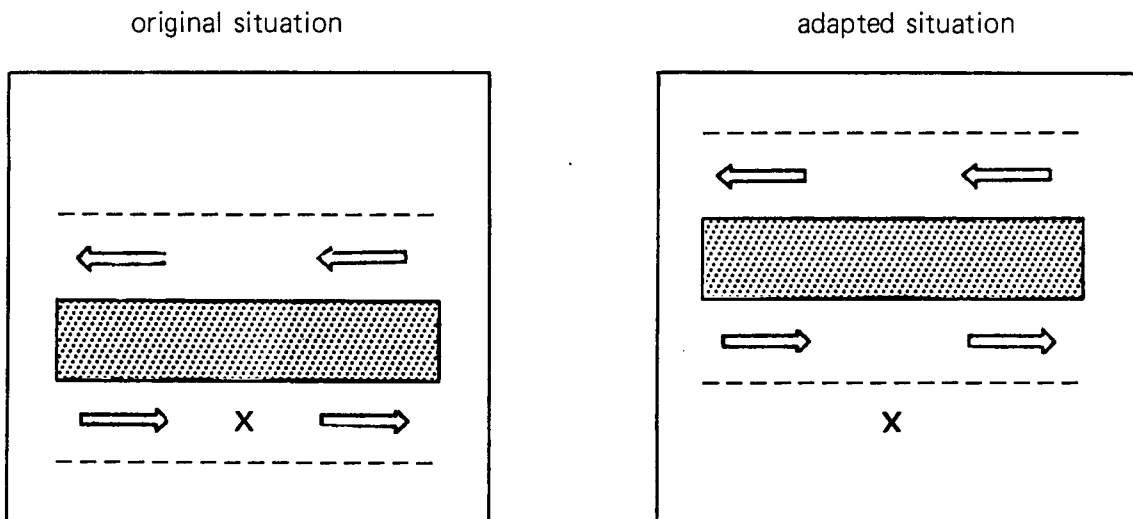

- (c) temporary local interruption of the scheme or part of the scheme in the area of location of the drilling rig. Such an interruption could be made a precautionary area;

Example

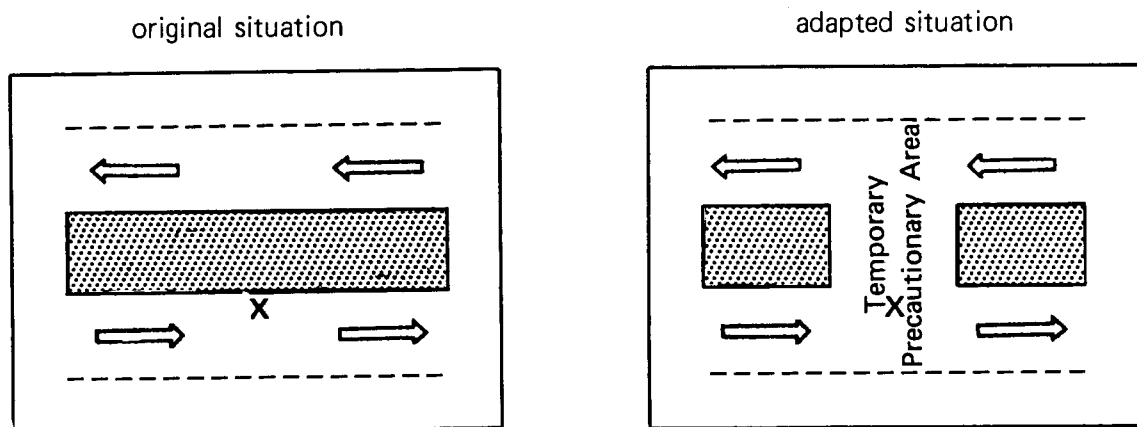

- (d) temporary suspension of the whole scheme.

7.3 In each case, exploration sites should be reviewed and such conditions specified as the Administration may deem necessary to ensure safety of navigation in the area.

7.4 Details of these temporary adjustments should be forwarded to the Organization and to appropriate hydrographic offices at least two months before the rig is positioned within an adopted traffic separation scheme so as to allow ample time for informing shipping.

8. THE USE OF ROUTEING SYSTEMS

8.1 Routeing systems are intended for use by day and by night in all weathers, in ice-free waters or under light ice conditions where no extraordinary manoeuvres or assistance by ice breaker(s) are required.

8.2 Routeing systems are recommended for use by all ships unless stated otherwise. Bearing in mind the need for adequate underkeel clearance, a decision to use a routeing system must take into account the charted depth, the possibility of changes in the sea-bed since the time of the last survey, and the effects of meteorological and tidal conditions on water depths.





8.3 A ship navigating in or near a traffic separation scheme adopted by the Organization shall in particular comply with Rule 10 of the International Regulations for Preventing Collisions at Sea, 1972 to minimize the development of risk of collision with another ship. The other rules of the 1972 Collision Regulations apply in all respects, and particularly the steering and sailing rules if risk of collision with another ship is deemed to exist.

8.4 At junction points where route traffic from various directions meet, a true separation of traffic is not really possible, as ships may need to cross routes or change to another route. Ships should therefore navigate with great caution in such areas and be aware that the mere fact that a ship is proceeding along a through-going route gives that ship no special privilege or right of way.

- 8.5 A deep water route is primarily intended for use by ships which because of their draught in relation to the available depth of water in the area concerned require the use of such a route. Through traffic to which the above consideration does not apply should, as far as practicable, avoid using deep water routes.
- 8.6 In two-way routes, including two-way deep water routes, ships should as far as practicable keep to the starboard side.
- 8.7 Arrows printed on charts in connexion with routeing systems merely indicate the general direction of established or recommended traffic flow; ships need not set their courses strictly along the arrows.
- 8.8 The signal "YG" meaning "You appear not to be complying with the traffic separation scheme" is provided in the International Code of Signals for appropriate use.

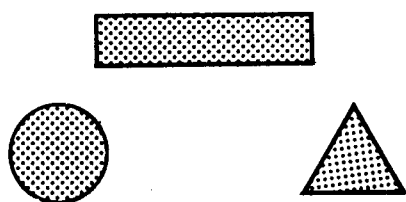
9. SYMBOLS

9.1 The symbols in the following table are those recommended by the International Hydrographic Organization for representation of details of routeing systems and associated measures on nautical charts. They are included for information on what may be generally found on charts. Individual countries may, however, use on their charts symbols differing from those given below.

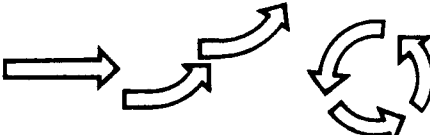
Detail (The figures in brackets refer to the Remarks)	Presentation	Description
1. Outside boundary of traffic lanes and two-way routes		Dashed line — the symbol used for maritime limits in general
2. Separation zone (of any shape) (1) (2)		A zone indicated by a tint light enough to reveal any hydrographic details
3. Separation line (2)		A tinted line at least 3 mm wide
4. Outside boundary of roundabout or precautionary area (3)		Dashed line — the symbol used for maritime limits in general
5. Centre of a roundabout which contains no central zone		A firm-line circle of at least 3 mm in diameter
6. Arrows indicating established direction of traffic flow (4)		Open-outlined arrows so situated and shaped as to indicate general direction of traffic flow

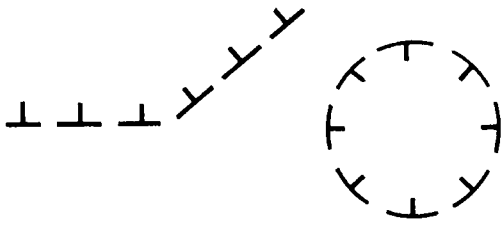
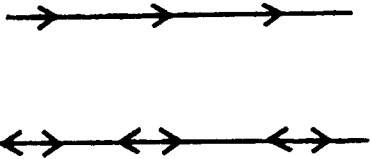
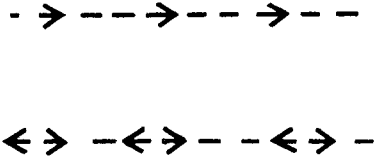
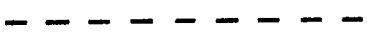
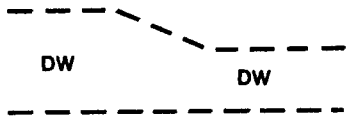
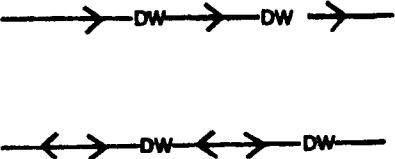
Detail (The figures in brackets refer to the Remarks)	Presentation	Description
7. Arrows indicating the recommended direction of traffic flow (certain stipulated classes of ships may be exempt) (4)		Dashed open-outlined arrows so situated and shaped as to indicate general recommended direction of traffic flow
8. Boundary of areas to be avoided (6) (5)		A line composed of a series of T-shaped signs, the cross bar of the T being long and the down stroke short and pointing towards the area in question, within which a suitable legend may be inscribed
9. Recommended track when based on a system of fixed marks (7)		A single continuous line in black or colour in which arrowheads are inserted at regular intervals either singly to represent a one-way track, or in opposing pairs to represent a two-way track
10. Recommended track when not based on a system of fixed marks (7)		A single dashed line, in black or colour, in which arrowheads are inserted at regular intervals either singly to represent a one-way track, or in opposing pairs to represent a two-way track
11. Outside boundary of deep water route		Dashed line — the symbol used for maritime limits in general
12. Deep water route with both outside boundaries depicted (8)		Dashed lines and the abbreviation DW inserted at regular intervals between them
13. Deep water route, based on fixed marks (8) (9)		A single continuous line in which arrowheads are inserted at regular intervals, either singly to represent a one-way route, or in opposing pairs, to represent a two-way route. The abbreviation DW is inserted at regular intervals along the continuous line

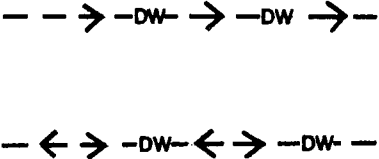
Detail (The figures in brackets refer to the Remarks)	Presentation	Description
14. Deep water route not based on fixed marks (8)		A single dashed line in which arrowheads are inserted at regular intervals; either singly to represent a one-way route, or in opposing pairs, to represent a two-way route. The abbreviation DW is inserted at regular intervals along the dashed line

Remarks

- (1) If the traffic lanes are separated by natural features (islands, marked shoals etc.) representation of the separation zone may be omitted.
- (2) Used also to mark the boundary between a traffic lane and an adjoining inshore traffic zone.
- (3) The dashed line representing the outside boundary of a roundabout should be broken at the junctions between the traffic lanes and the roundabout. This may also be done for precautionary areas if considered appropriate.
- (4) It is preferable that the arrows be inserted in dispersed or staggered formation, instead of placing them in straight lines.
- (5) Notes on conditions of avoidance (classes and sizes of ships, nature of cargoes carried, etc.) may be given on charts and should always be given in Sailing Directions.
- (6) This symbol is also used to indicate the boundary of offshore exploration and exploitation areas where navigation may be dangerous.
- (7) A usual feature of recommended tracks is that they occur fairly close inshore and are intended primarily to help ships avoid shoal depths, rather than to regulate shipping movements. In such cases, they are usually charted in black.
- (8) When the minimum depth along a **DW** route is considered critical, the depth may be indicated beside the abbreviation **DW**. However, unless the critical depths within the limits of the **DW** route are regularly examined and confirmed by a competent harbour, regional or national authority, it is unlikely that such a minimum depth can be quoted on the chart. The least depths obtained during the survey investigation of the **DW** route will be apparent by the display of selected soundings shown on the chart in the usual manner. In some cases, a NOTE on the chart gives further information regarding date of survey, etc.
- (9) The symbols 13 and 14 in the table above are identical to those for Recommended Tracks (see symbols 9 and 10) with the addition of abbreviation **DW**. Particularly on a two-way route, deep draught vessels will rarely be able to adhere strictly to a single centre line and, for this reason, it is preferable that a **DW** route be shown on charts by symbol 12 which clearly indicates the extent of the area which has been accurately surveyed for clearance of sea bottom and submerged objects.

General observations

- 9.2 The International Hydrographic Organization has recommended that routeing and traffic separation symbols used on charts should be printed in colour, preferably magenta.
- 9.3 Secondary details of routeing and traffic separation, such as figures indicating directions of traffic, schemes and their details, dimensions, distances from coast etc., should not be shown on charts unless considered critical. These may, however, be given in Sailing Directions, if so decided by hydrographic offices.